

INDUSTRIAL VACUUM CLEANER EN

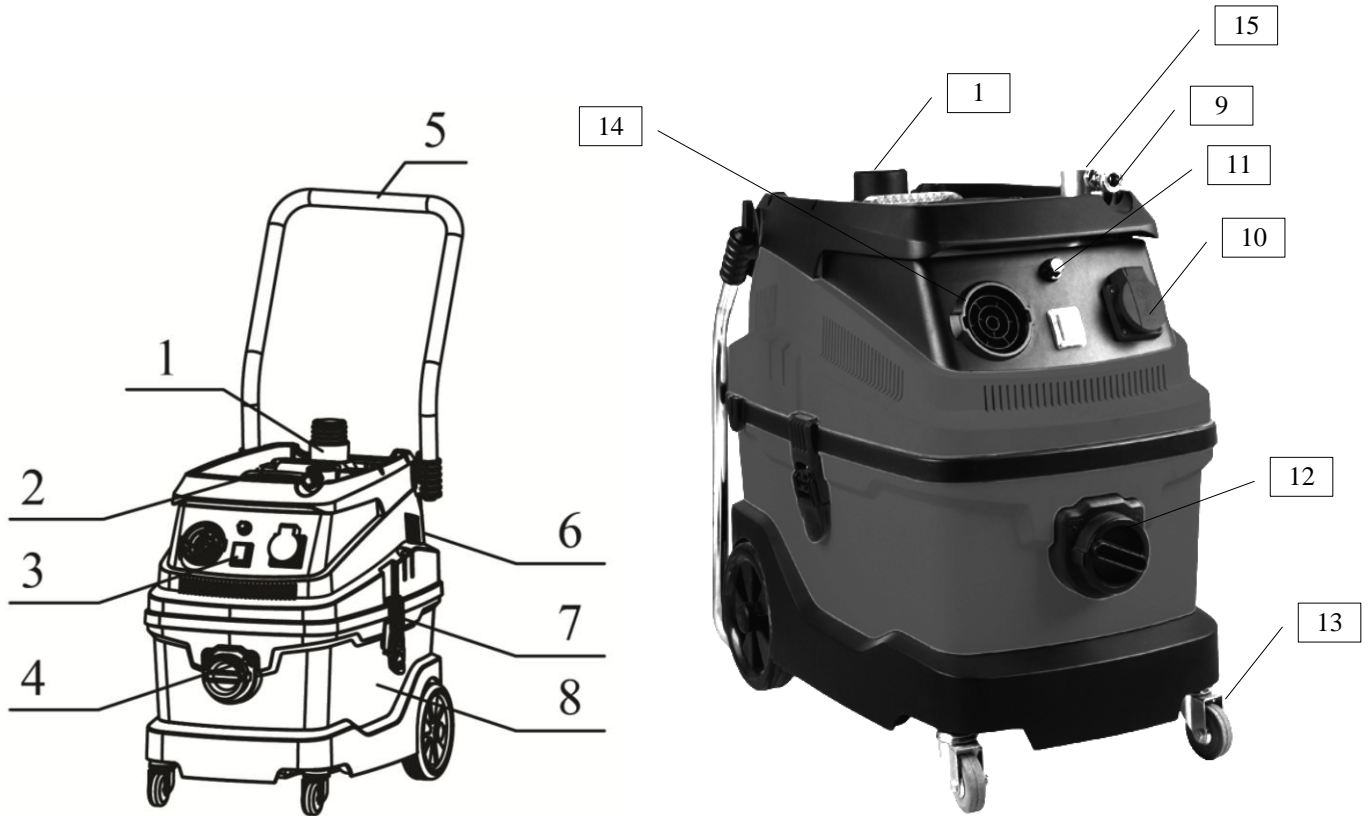

Picture 1

PARTS OF THE TOOL	
1	Upper hose nozzle
2	Handle
3	On/Off
4	Front hose nozzle
5	Handle
6	Power cord
7	Head lockers
8	Water tank
9	Pneumatic tool connection
10	Electric tool socket
11	Speed control
12	Rubber cap
13	Castor wheels with lock
14	Operating air outlet
15	Compressed air inlet (not shown)
	Identification plate (not shown)

INDUSTRIAL VACUUM CLEANER EN

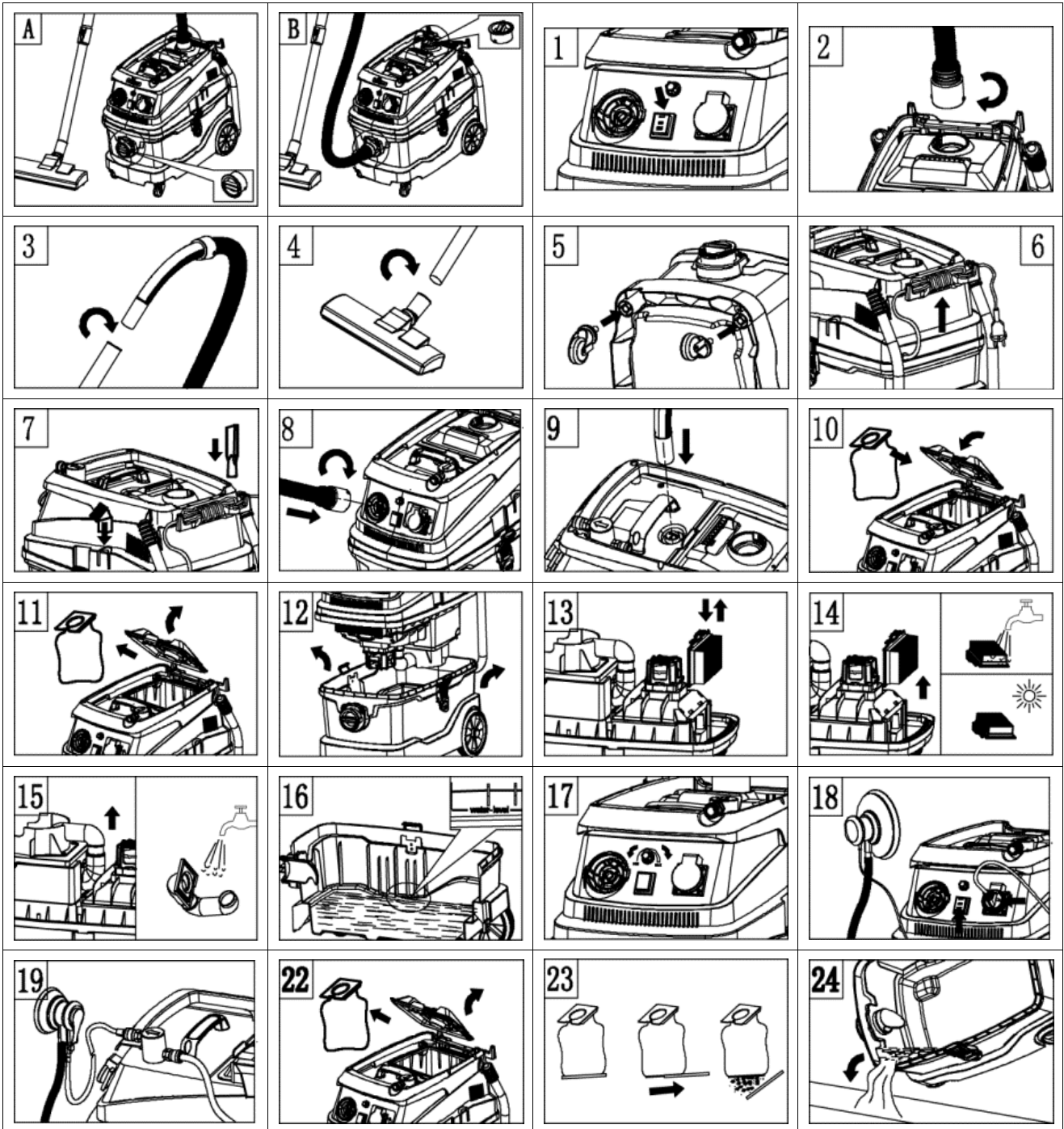

INDUSTRIAL VACUUM CLEANER EN

TECHNICAL DATA	
Operating voltage and frequency	220-240 VAC - 50/60 Hz
Power	1600 W
Power at socket (max)	2000 W, Class 1
Total power (max)	3600 W
Air capacity	119 m ³ /h
Vacuum level	180 hPa
Weight Brutto/Netto	15 / 12 kg
Dimensions	600 x 375 x 575 mm
Class of protection	IPX 4
Noise level EN 60704-3	73 dB (A)
Container capacity	8 L
Inlet air pressure	6 bar
Max compressed air flow	1400 L/min

PICTOGRAMS



Read the following instruction first before operating the product



Important safety indications



Caution! This appliance contains dust hazardous to health. Emptying and maintenance operations, including removal of the dust collection means, must be carried out only by authorized personnel wearing suitable personal protections. Do not operate without the full filtration system fitted.

GENERAL EQUIPMENT SAFETY WARNINGS



WARNING! Read all safety warnings and all instructions. Failure to follow the warnings and instructions may result in electric shock, fire and/or serious injury. Save all warnings and instructions for future reference.

The term “equipment” on the warnings refers to your mains-operated (corded) Mobile Vacuum Cleaner.

1) WORK AREA SAFETY

- Keep work area clean and well lit. Cluttered or dark areas invite accidents.
- Do not operate equipment in explosive atmospheres, such as in the presence of flammable liquids, gases or dust. Equipment creates sparks which may ignite the dust or fumes.
- Keep children and bystanders away while operating equipment. Distractions can cause you to lose control.

2) ELECTRICAL SAFETY

- Equipment plugs must match the outlet. Never modify the plug in any way. Do not use any adapter plugs with earthed (grounded) equipment. Unmodified plugs and matching outlets will reduce risk of electric shock.
- Avoid body contact with earthed or grounded surfaces, such as pipes, radiators, ranges and refrigerators. There is an increased risk of electric shock if your body is earthed or grounded.
- Do not expose equipment to rain or wet conditions. Water entering equipment will increase the risk of electric shock.
- Do not abuse the cord. Never use the cord for carrying, pulling or unplugging the equipment. Keep cord away from heat, oil, sharp edges or moving parts. Damaged or entangled cords increase the risk of electric shock.
- When operating a equipment outdoors, use an extension cord suitable for outdoor use. Use of a cord suitable for outdoor use reduces the risk of electric shock.
- If operating equipment in a damp location is unavoidable, use a residual current device (RCD) protected supply. Use of an RCD reduces the risk of electric shock.

3) PERSONAL SAFETY

- Stay alert, watch what you are doing and use common sense when operating equipment. Do not use equipment while you are tired or under the influence of drugs, alcohol or medication. A moment of inattention while operating equipment may result in serious personal injury.
- Use personal protective equipment. Always wear eye protection. Protective equipment such as dust mask, non-skid safety shoes, hard hat, or hearing protection used for appropriate conditions will reduce personal injuries.
- Prevent unintentional starting. Ensure the switch is in the off-position before connecting to power source, picking up or carrying the equipment. Carrying equipment with your finger on the switch or energising equipment that have the switch on invites accidents.
- Remove any adjusting key or wrench before turning the equipment on. A wrench or a key left attached to a rotating part of the power tool may result in personal injury.
- Do not overreach. Keep proper footing and balance at all times. This enables better control of the power tool in unexpected situations.
- Dress properly. Do not wear loose clothing or jewellery. Keep your hair, clothing and gloves away from moving parts.

Loose clothes, jewellery or long hair can be caught in moving parts.

g) If devices are provided for the connection of dust extraction and collection facilities, ensure these are connected and properly used. Use of dust collection can reduce dust-related hazards.

4) **EQUIPMENT USE AND CARE**

a) Do not force the equipment. Use the correct power tool for your application. The correct power tool will do the job better and safer at the rate for which it was designed.

b) Do not use the equipment if the switch does not turn it on and off. Any equipment that cannot be controlled with the switch is dangerous and must be repaired.

c) Disconnect the plug from the power source from the equipment before making any adjustments, changing accessories, or storing equipment. Such preventive safety measures reduce the risk of starting the equipment accidentally.

d) Store idle equipment out of the reach of children and do not allow persons unfamiliar with the equipment or these instructions to operate the equipment. Equipment are dangerous in the hands of untrained users.

e) Maintain equipment. Check for misalignment or binding of moving parts, breakage of parts and any other condition that may affect the equipment's operation. If damaged, have the equipment repaired before use. Many accidents are caused by poorly maintained equipment.

f) Use the equipment, accessories and tool bits etc. in accordance with these instructions, taking into account the working conditions and the work to be performed. Use of the equipment for operations different from those intended could result in a hazardous situation.

5) **SERVICE**

a) Have your equipment serviced by a qualified repair person using only identical replacement parts. This will ensure that the safety of the equipment is maintained.

INSPECTION OF PACKAGE CONTENTS

The package contains:

- 1 device equipped with a power cable and socket;
- 2 suction hose;
- 1 paper dust bag;
- 1 cloth dust bag;



For packaging waste disposal attain to local regulations in force, including recycling disposal if requested.

SAFETY AND ACCIDENT PREVENTION INSTRUCTIONS

WARNINGS

- This equipment can only be operated by trained people in charge; machine not intended to be operated by kids or mental-sensorial defective people;
- Before use, users should be provided with information, instruction and training for the use of the appliance and the pollutant it is used for, including the right method for the safe removal and disposal of the substances collected;
- It is necessary to provide an adequate air change rate in the room if the exhaust air is returned in the room. Reference to National Regulations is necessary;
- The temperature of the work area must be between 10°C and 35°C with humidity between 50% and 90%;
- The surface on which the machine rests must not exceed a maximum 10 degree gradient
- Always unplug the equipment when not in use, before maintenance or cleaning, and before replacing the dust bag or filters;
- Do not pull the power cord to unplug the equipment;
- Keep the power cord away from heat oil and sharp edges;
- In the event of a blackout, turn the tool switch in OFF position to avoid accidental start when power comes back;
- Do not expose the equipment to rain and low temperatures;
- Do not lift and transport the equipment by the handle with a lifting device.

EXPLOSION OR FIRE HAZARD



- Do not vacuum flammable or explosive dust (i.e. magnesium, aluminium, etc.);

- Do not vacuum sanding dust from surfaces treated with paints that have not completed the catalyst cycle;
- Do not vacuum sparks or white hot shavings;
- Immediately disconnect the vacuum from the electrical mains if dust is ejected from air outlet;
- Do not vacuum flammable or explosive liquids (i.e. petrol, thinners, etc.);
- Do not vacuum aggressive liquids or substances (i.e. acids, bases, solvents, etc.).

SPECIFIC USE

- This appliance is suitable for heavy duty and industrial operations in accordance with EN60335-1 e EN60335-2-69;
- This appliance is suitable for commercial use: i.e. hotels, school, hospitals, factories, shops, offices and rental business;
- The front power socket is only intended for specific use as indicated in the present instruction manual.

START-UP

ASSEMBLY

- Mounting of the dust extraction hose (2)

Insert the hose fitting into the hole located on the top of the vacuum cleaner and turn it clockwise until it locks.

To detach the hose, hold the hose and turn the hose fitting counter-clockwise and remove it.

- Mounting of the extension to the dust extraction hose (3)

Attach the extension to the hose connector and lock it by turning it clockwise. To detach the extension, hold the extension by one hand and detach the hose connection by turning it counter-clockwise with the other hand.

- Mounting of the floor brush (4)

Attach the brush hose to the extension and lock it by turning it clockwise. To detach the floor brush, hold the extension by one hand and detach the floor brush hose by turning it counter-clockwise with the other hand.

- Installation of the front wheels (5)

Remove the upper part of the vacuum cleaner body. Insert the steering axles of the two front wheels as far as they will go into the corresponding holes located on the lower part of the vacuum cleaner body.

- Storing of the power cord (6)

When the vacuum cleaner is not in use, store the cord on a special holder located on the back of the vacuum cleaner.

- Storing of accessories (7)

Store accessories in special holes located on the both sides of the top part of the vacuum cleaner.

- Blow function (8)

Insert the hose fitting into the hole located on the front part of the vacuum cleaner.

- Improvement of suction power (9)

If the suction power has decreased press the button using the hose fitting for 3-5 times to increase the suction power.

POWER SUPPLY

- Turn the main switch (Pos. 7, Picture 1) to "0" (Off) before connecting this appliance to the supply mains;
- Supply mains voltage and frequency must match the identification plate;
- Connect to power socket outlets provided with earth conductor and adequate protections.

COMPRESSED AIR MAINS

- Do not exceed 6 bar;
- Dehumidified and filtered air required;
- Connect the appliance to the compressed air main with an hose suitable for the air pressure and int. diam. 10 mm min.

ELECTRICAL TOOL CONNECTIONS

- Check for the tool switch turned off before connecting it to the front panel socket outlet;
- Insert the tool plug into the front panel socket (Pos. 16, Picture 1) and (18);
- Connect the tool to the hose nozzle with the hose (Pos 18, Picture 1);
- Do not plug electric tools exceeding the power indicated on the front panel.

PNEUMATIC TOOL CONNECTIONS

INDUSTRIAL VACUUM CLEANER **EN**

- Check for the tool switch turned off before connecting it to the front panel quick coupling;
- Connect the tool to the appliance with the quick couplings (Pos. 15, Picture 1) and (19);
- Connect the coaxial hose (optional) to the quick coupling (Pos 18, Picture 1).
- Check the tool functioning as indicated on their instructions manual.

PRELIMINARY CHECKS

- Check that the dust collection bag (10) has been fitted in the container and that the filters (13) have been fitted on the head;
- Check that the vacuum hose is properly fixed and does not hinder tool movement
- Check that there are no leaks in the compressed air supply system.

MACHINE USE

- Motor rotation speed control (17)

The speed control knob is located above the switch. Turn the control knob counter-clockwise to decrease the suction power or clockwise to increase the suction power.

- Synchronization with power tools (18)

1. Connect the vacuum cleaner using the dust extraction hose with a dust extraction outlet of a power tool.
2. Insert the tool plug into the socket located on the front panel of the vacuum cleaner to synchronize the electrical part.
3. Turn on the vacuum cleaner. Turn on the power tool and the vacuum cleaner will start automatically.

- Synchronization with pneumatic tools (19)

1. Connect the vacuum cleaner using the dust extraction hose with a dust extraction outlet of a pneumatic tool.
2. Insert the connector of the pneumatic hose of the tool into the connector on the top panel of the vacuum cleaner to synchronize the pneumatic part.
3. Turn on the vacuum cleaner. Turn on the pneumatic tool and the vacuum cleaner will start automatically.

 After operating in hazardous dust contaminated environment all appliance parts must be considered as contaminated; before handling the appliance out the 1 contaminated area or servicing it, remove all the dust from it with vacuum or cloth, seal the dust container, and store hose and accessories in a bag.

MAINTENANCE

 A yearly technical check on parts and filtering system by an authorized service centre is required.

ORDINARY CHECK OPERATIONS

 For user servicing, the appliance must be dismantled, cleaned and serviced, /1\ as far as it is reasonably practicable, without causing risk to the maintenance staff and others. Suitable precautions include, decontamination before dismantling, provision for local filtered exhaust ventilation where the appliance is dismantled (according to local regulations), cleaning of the maintenance area and suitable personal protection.

- Check the vacuum hose conditions;
- Check the power cord, plug and outlet socket conditions: in case contact an authorized service centre for replacement;
- Check the dust bag: do not exceed recommended weight and capacity! In case of laceration or perforation of the dust bag check the filter cartridge and eventually ask for replacement to an authorized service centre;
- Check filter cartridges condition (13). In case of lacerations or perforations contact an authorized service centre for replacement.

 Do not use the appliance without the full filter set fitted!

BAG REPLACEMENT

 Do not spread dust during dust bag replacement!

- Installation of the dust bag (10)

Remove the transparent cover. Install the dust bag and lock it in the vacuum cleaner. Mount the cover on its place.

- Replacement of the dust bag (11)

Remove the transparent cover. Remove the old dust bag and install a new one; lock it in the vacuum cleaner. Mount the cover on its place.

INDUSTRIAL VACUUM CLEANER **EN**



Only use genuine HUBERTH dust bags. Spare bags should be kept in dry places! Follow local legal regulations for disposal.

FILTER REPLACEMENT



Do not spread dust during filter replacement!

- Removing the upper part of the vacuum cleaner (12)

To remove the upper part, open two latches and pull the upper part of the vacuum cleaner by the handle.

- Filter replacement (13)

Remove the upper part of the vacuum cleaner. Remove the filter located on the lower part of the vacuum cleaner body. Install a new filter and assemble the vacuum cleaner in reverse order.

- Filter cleaning (14)

Remove the filter as described above and rinse it with water. After the filter is completely dried, reinstall and reuse it.

- Connector cleaning (15)

Remove the connector from the top of the vacuum cleaner and rinse it with water. Reinstall the connector and make sure it is locked securely.

- Water quantity control (16)

Remove the top part of the vacuum cleaner. Use the water level to control the amount of water at the bottom part of the vacuum cleaner. Drain the excess amount of water if necessary.

- Removal of dust from the dust bag (22, 23)

Remove the dust bag from the vacuum cleaner, as described previously. Gently slide the lower flap of the bag and remove the dust. Reinstall the flap and insert the dust bag back into the vacuum cleaner.

- Removal of contaminated water from the vacuum cleaner (24)

Move the vacuum cleaner to the sewage drain. Remove the top part of the vacuum cleaner. Tilt the vacuum cleaner container in a way that the contaminated water begin to flow out. Wait until the container is completely drained. Rinse the container with clean water and assemble the vacuum cleaner in reverse order.

TOOL IDENTIFICATION PLATE

POSITION AND MEANING OF INFORMATION

1. Type of tool.

2. Nominal working voltage Volts (V).

3. Working frequency Hertz (Hz).

4. Class of protection.

5. Absorbed power Watt (W).

6. Power at socket (MAX) Watt (W).

7. Power max Watt (W).

8. Serial number.



9. Read all these instructions before operating this product and save these instructions.

TROUBLESHOOTING AND SOLUTION

EFFECTS	CAUSES	SOLUTIONS
The motor will not start	No power	Make sure the unit is plugged in
	Power cord, switch or motor defective	Contact an authorised service centre
The vacuum does not start automatically	Electronic module	Contact an authorised service centre
Vacuum flow is insufficient	Bag full	Check the filter bag
	One of the hoses or accessories is clogged	Check the flexible hose and the accessories
	Clogged filters	Check the filters cartridges
Dust from the exhaust	Filter cartridge torn ripped	Contact an authorised service centre
Tools do not start	3-way switch malfunction	Contact an authorised service centre
Insufficient Power for pneumatic tool	Insufficient compressed air feeding	Check air passage

DISPOSAL (WEEE DIRECTIVE)



At the end of its useful life, the product, pursuant to European Directive 2002/96/CE (WEEE) + 2003/108/CE and its implementation in national law, must not be released into the environment or thrown away as domestic waste, but must be disposed of at authorized recycling centers (contact the relevant local authorities for a list of places where the product may be disposed of according to the law). Disposing of the product correctly contributes to protecting human health and safeguarding the environment. Any illegitimate disposal of the product will be punishable by law.